

PRODUCT CATALOGUE

FACADE, ROOF AND COLUMN CLADDING

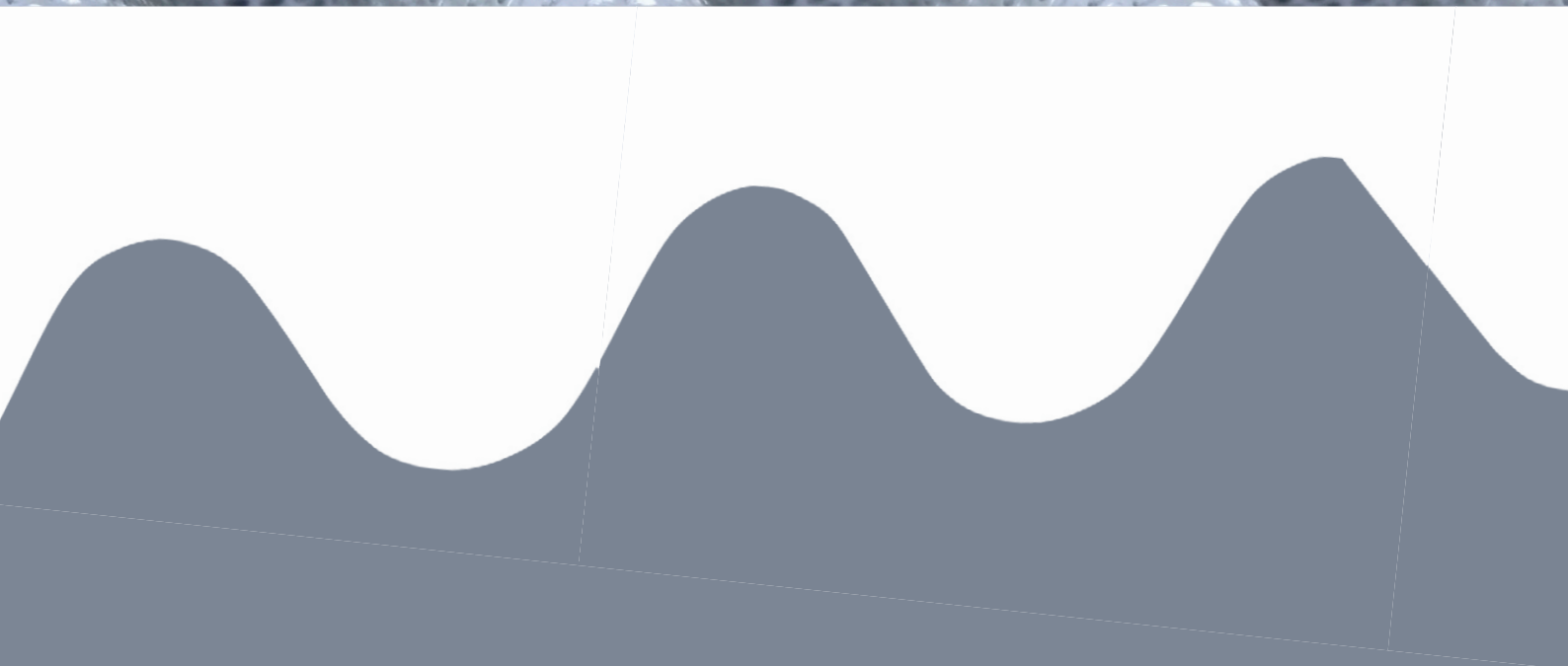

MN[®] WELCOME TO THE WORLD OF MODERN METAL PROCESSING

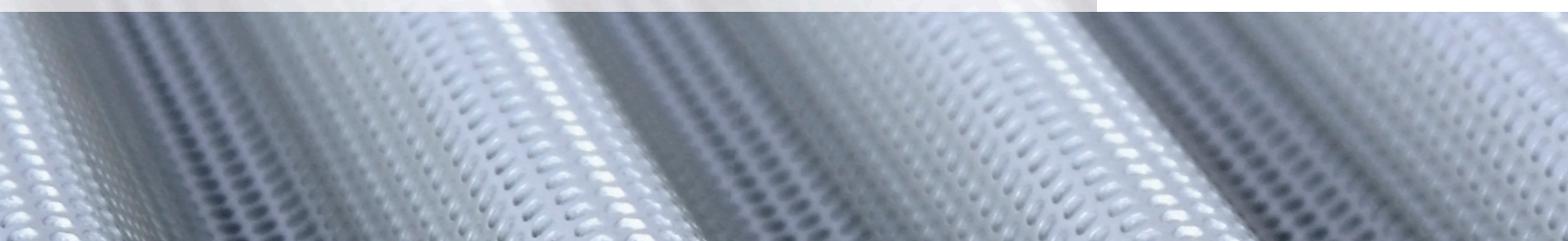
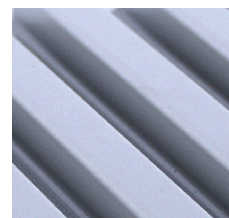
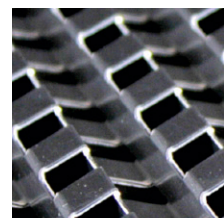

wellTEC[®] profile SP3G-50/60 R-115, AlMg1, anodised

CONTENTS

wellTEC [®]	DESIGN PROFILES FOR FACADE, ROOF AND WALL	04 – 23
planTEC [®]	CASSETTE SYSTEMS, SHINGLES AND PERFORATED AND EMBOSSED SHEETS	24 – 39
colTEC [®]	COLUMN CLADDING	40 – 45
Special solutions	CUSTOMISED AND EXCLUSIVE BUILDING CLADDING	46 – 47
Flashings	CONSTRUCTION PROFILES IN ALL MATERIALS	48 – 53
Company	CONSULTING, PROJECT DESIGN AND PRODUCTION	54 – 55

Exclusive architecture design, from small features to functional industrial buildings: *welcome to the world of MN Metall*.

In order to offer this service portfolio with the highest levels of quality, exceptional flexibility and expertise are required. At MN Metall, this already begins during the project design and consultation stages, and stretches through production all the way to logistics.

The focus is always on an impressive range of top-quality products. MN processes a wide variety of materials, including aluminium, stainless steel, copper, steel and titanium zinc with diverse surfaces. Thanks to cutting-edge technol-

ogy, profile sheets can be produced in maximum sizes and minimum thicknesses. This results in high-quality sheets for facade design, modern column cladding, cassette panels and shingles, in addition to functional perforated and embossed sheets for walls or ceilings.

Discover the virtually endless options available for building cladding, too.

Learn more about our dimensionally precise system solutions or contact us if you require customised production.

Whether serial production or project business, MN Metall looks forward to taking care of your requirements with meticulous accuracy, creativity and reliability.



Isabella Stewart Gardner Museum, Boston, MA | USA
Architect: Renzo Piano Building Workshop, Genoa | Italy
Building cladding construction: Gartner GmbH, Gundelfingen



wellTEC® profile SZ-14/33, copper patina

AS DIVERSE AS YOUR IDEAS

wellTEC® DESIGN PROFILES FOR FACADE, ROOF AND WALL

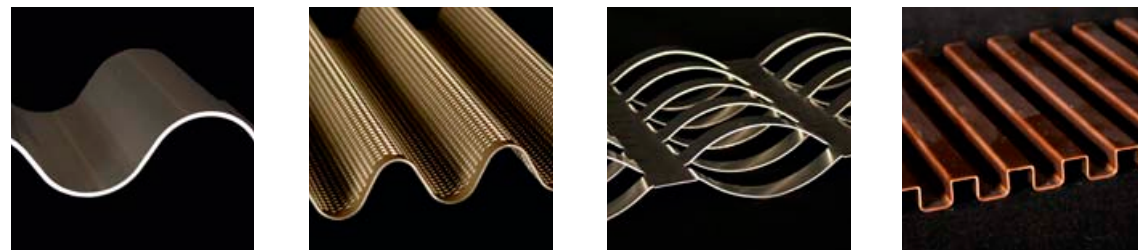

wellTEC® design sheets now distinguish an ever-increasing number of iconic buildings both at home and abroad due to the wide variety of products and the flexible profile processing that meets practically every requirement imaginable. From standardised corrugated, trapezoidal or zigzag profiles to customised production, wellTEC® is the ideal solution for modern building cladding. All metals are available with diverse surfaces, including variable grids and perforations.

Our expert team is also on hand to work with clients in the creation of customised, cost-effective solutions and designs, providing assistance all the way to production or even installation on suitable substructures. If you want to let your creativity run free in the design of your facades, roofs and walls without having to renounce high dimensional accuracy and product quality, wellTEC® design sheets by MN Metall are the solution for you!

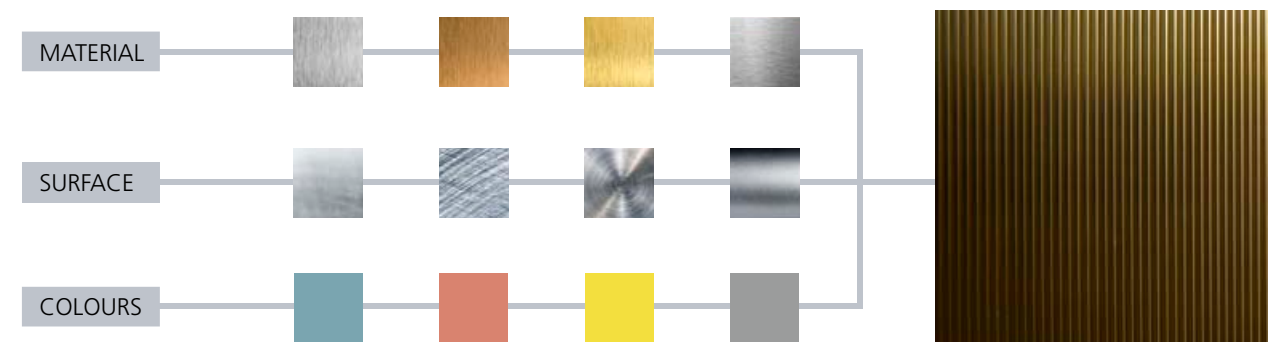

MATERIAL RANGE

Every building project presents different requirements in terms of construction, sustainability and design. To cater for this, wellTEC® design sheets can be produced in all metals. This includes aluminium, stainless steel, copper, steel, titanium zinc, brass and all other metals.

SURFACE RANGE

You decide which surface presents the optimal solution. wellTEC® design sheets are available in every finish imaginable, from stained, polished and sandblasted to patterned, anodised or etched.

COLOUR RANGE

Everyone has different tastes. It's just as well, then, that alongside our exhaustive selection of materials and surfaces, we also offer an extensive array of colours. MN Metall supplies structures in all RAL colours and shades as high-quality PE or PVDF paints.



Irregular zigzag profile SZ-25/50-R, reflective, brass

OTHER ADVANTAGES OF wellTEC[®]



Corrugated sheets at Berlin-Spandau ICE train station

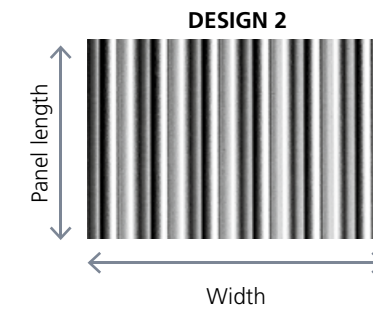
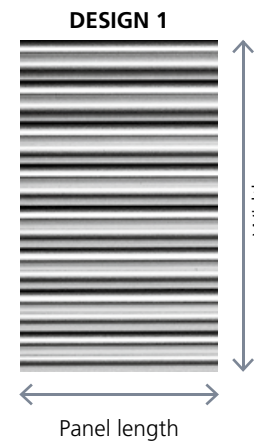

Station platform roofs, type GMP-1

CUSTOMISED SOLUTIONS

Let your ideas run free. The wide range of options presented by wellTEC[®] results in more than 60 basic shapes that can be combined as required. It goes without saying that we can also tailor profiles in terms of length, dimensions, perforations and shapes to suit you. Upon request, wellTEC[®] design sheets can be produced in lengths or widths of up to 5,500 mm and

in thicknesses from 0.5 mm to 5 mm. They are available with concealed fixtures and can be produced to meet the specific conditions of the construction site in question or supplied as complete components. And if you are looking for special sizes in other materials, just let us know – we'd be delighted to help!

WIDTH

Cutting-edge machine technology and a high degree of expertise enable the production of special sizes with low tolerances.

DESIGN 1
Width: ~1,000 mm (depending on profile shape)
Panel length: max. 3,000 mm or 5,500 mm (depending on profile shape)

DESIGN 2
Width: max. 5,500 mm (depending on profile shape)
Panel length: max. 1,500 mm (depending on profile shape)

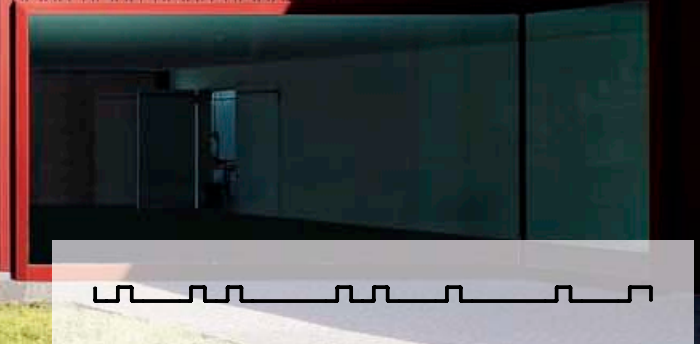

Irregular special profile SQ-20/20-R, AlMg1, Sandalor® anodised

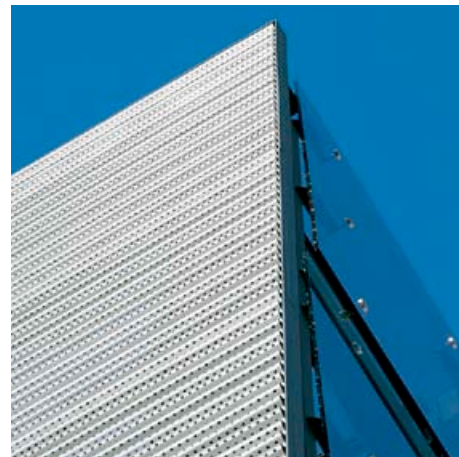

Canopy with precision butt joints for the entrance area of the ZKM Center for Art and Media in Karlsruhe

PERFORATIONS

The sky is the limit in terms of functionality and design: sheets can be supplied with complete or partial perforations.

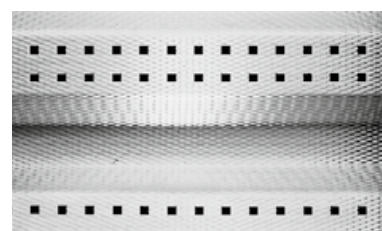
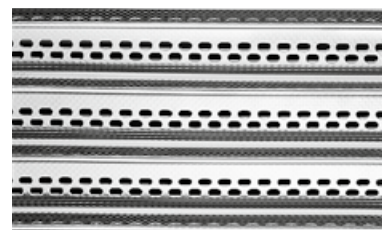
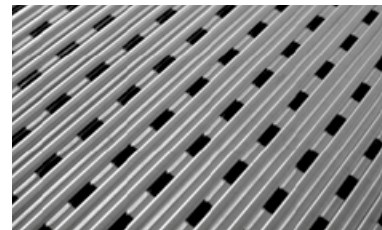
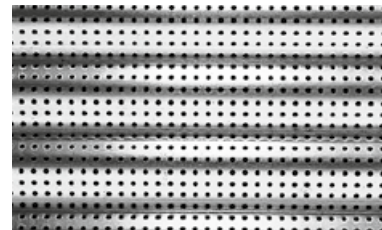

New exhibition halls, Cologne: Cladding with a high-quality AlMg polyester coating

EDGING AND WEBS

welTEC® profiles are distinguished by their variety of patterns and corrugated patterns. These can be fixed with customised edging without the need for additional angles or sheets. This advantage also makes it easier to compensate for any unevenness in the construction.

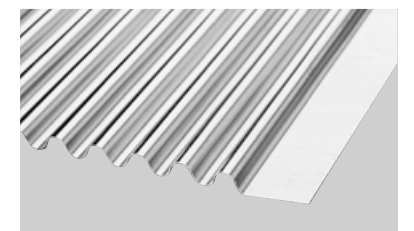
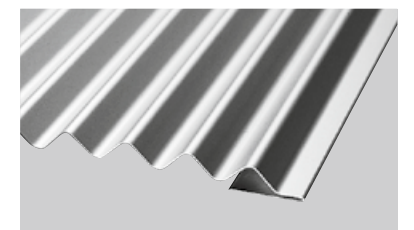
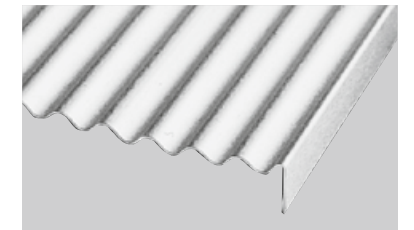

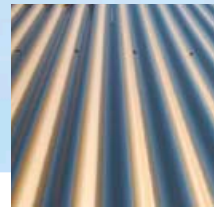

wellTEC® W-27/100, AlMg1, painted in two colours



Dome of the Staatliches Museum
in Schwerin, Mecklenburg-Western Pomerania

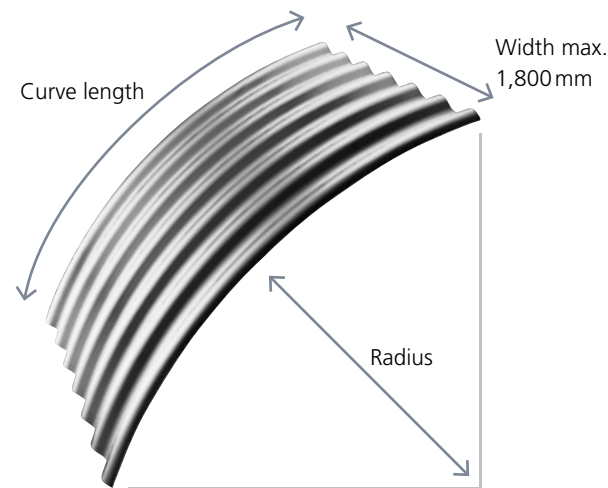

CURVES

wellTEC® design sheets are also available in a 'bowed' version. These are used for tunnel linings, special railway wagons, canopies, etc. Bowed sheets are also available with tapering towards one end, also making wellTEC® an excellent option for cladding domes.

Sheet thicknesses: $t = 0.5\text{--}1.0\text{ mm}$
 Smallest radius: $t = 0.5\text{ mm} = 3,000\text{ mm}$
 With sheet thickness: $t = 0.7\text{ mm} = 1,200\text{ mm}$
 $t = 1.0\text{ mm} = 1,000\text{ mm}$

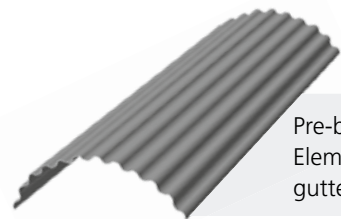

Pre-bowed wellTEC®
Element for columns,
gutters, etc.

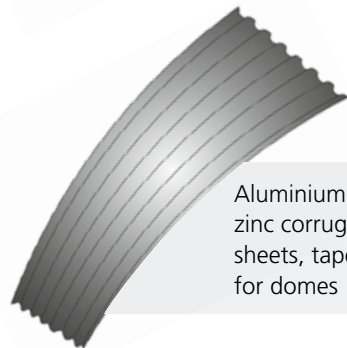

Aluminium and titanium
zinc corrugated bowed
sheets, tapered to one side
for domes



Facade cladding of the IMAX pyramid
in Eilat, Israel



Practically all profile shapes are possible

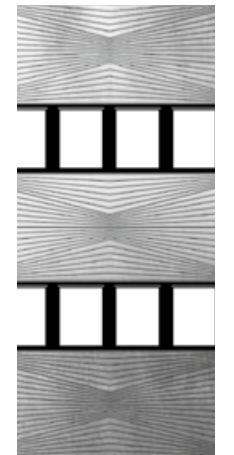

DIAMOND PATTERN

wellTEC® design sheets can be produced in practically all profile shapes. Depending on the requirements, a diverse range of diamond patterns can be used to create a bulky or fine surface structure.

ARTICLE NUMBER DRAWING MAX. LENGTH IN MM

W-1.5/3 Also available bowed 3,000



W-1.5/5 Also available bowed 3,000



W-2.5/9 Also available bowed 3,000

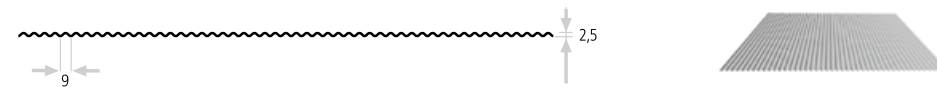

W-4/10 Also available bowed 1,500

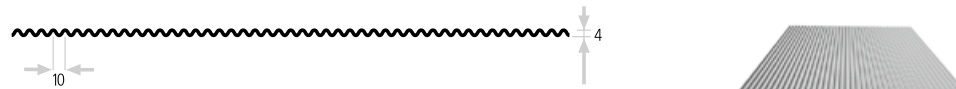

W-6/15 Also available bowed 3,000

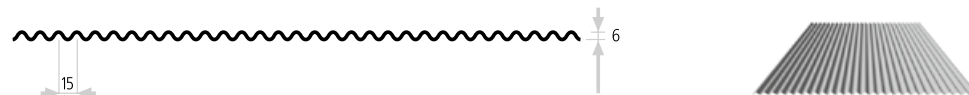

W-6/32 Also available bowed 5,500

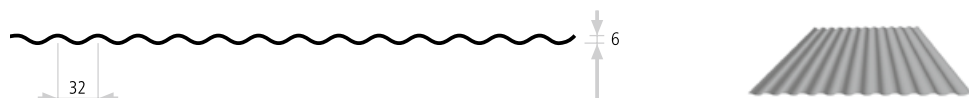

W-8/25 Also available bowed 5,500



W-8/120 Also available bowed 5,500



Scalloped and zigzag flashing for all profiles. The dimensions given for profile height and width are approximate only.

ARTICLE NUMBER DRAWING MAX. LENGTH IN MM

W-10/60 Also available bowed 5,500



W-15/40 Also available bowed 5,500



W-18/76 Also available bowed 5,500



W-20/40 Also available bowed 5,500



W-20/50 Also available bowed 5,500



W-20/70 Also available bowed 5,500



W-20/80 Also available bowed 3,900



W-27/100 Also available bowed 5,500



All of our welltec® products are also available in perforated versions with single-hole patterns, complete perforation, etc.

ARTICLE NUMBER DRAWING MAX. LENGTH IN MM

W-27/111 Also available bowed **5,500**

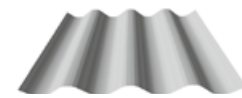

W-30/135 **5,500**

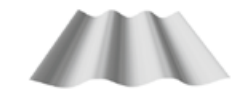

W-40/125 **5,500**

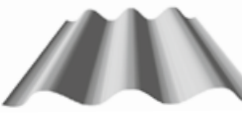
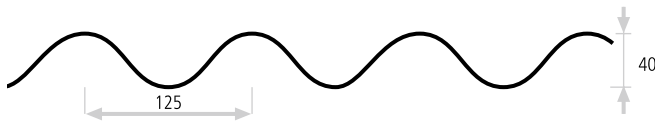

W-42/160 **5,500**

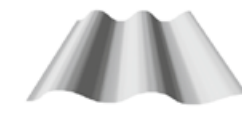
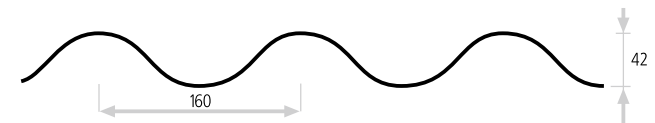

W-45/60 **5,500**

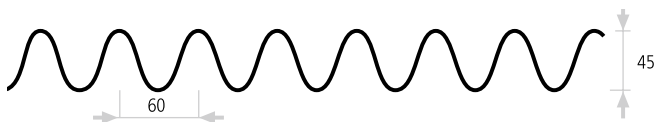

W-45/129 **5,500**

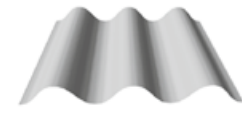
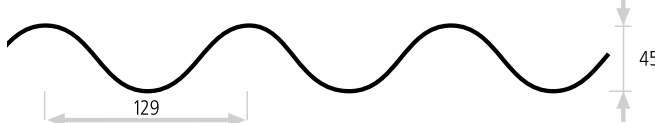

W-45/150 **5,500**

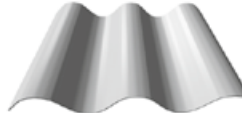

W-48/100 **5,500**

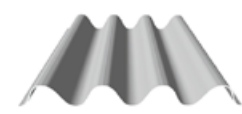
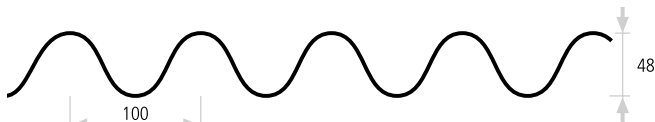

ARTICLE NUMBER DRAWING MAX. LENGTH IN MM

T-2.5/82 **5,500**

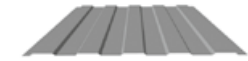
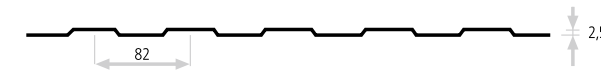

T-3/20 **3,000**

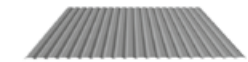
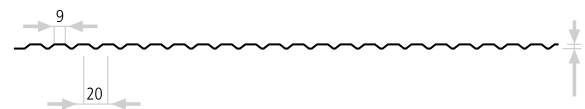

T-10/30 **3,000**

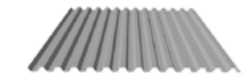

T-15/45 **3,000**

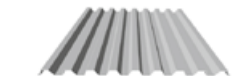
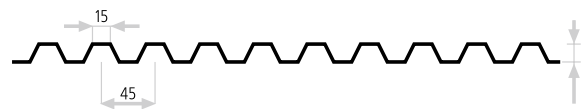

T-20/60 **5,500**

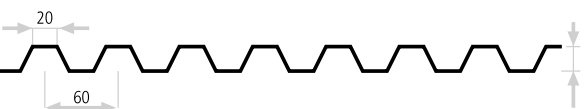

T-21/146 **5,500**

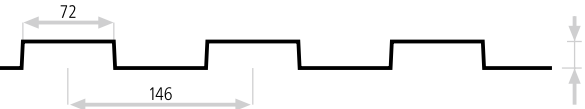

T-25/75 **5,500**

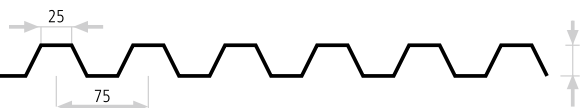

T-26/167 **5,500**

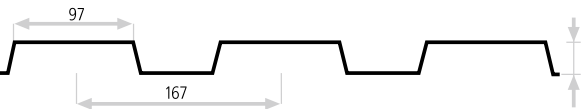

ARTICLE NUMBER DRAWING MAX. LENGTH IN MM

T-35/125  **3,000**

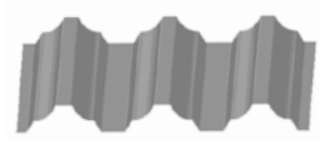
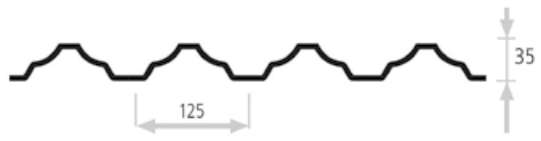

T-50/150  **5,500**

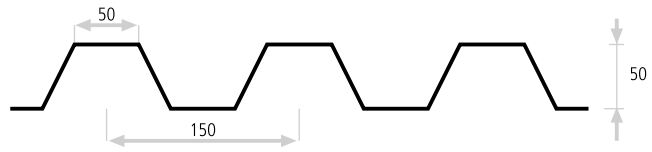

T-100/275  **5,500**

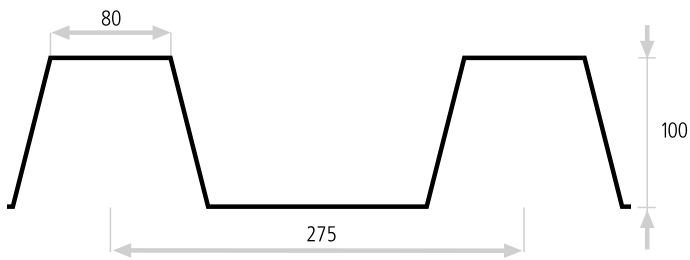

ARTICLE NUMBER DRAWING MAX. LENGTH IN MM

Z-10/30  **3,000**

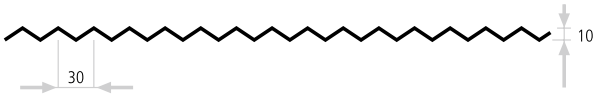

Z-13/26  **5,500**



Z-15/45  **3,000**

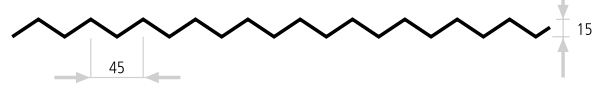

Z-20/40  **5,500**



Z-20/60  **3,000**

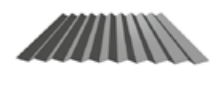
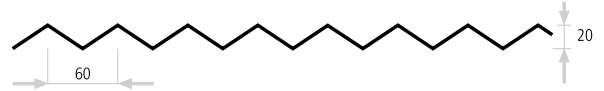

Z-25/80  **5,500**

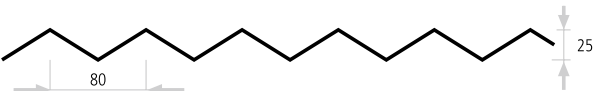

Z-50/120  **3,000**

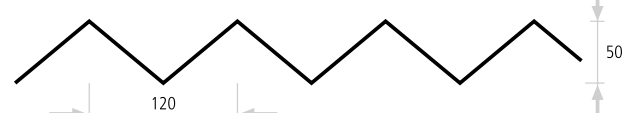

ARTICLE NUMBER	DRAWING	MAX. LENGTH IN MM
ST-H-R	Also available bowed	3,000/5,500

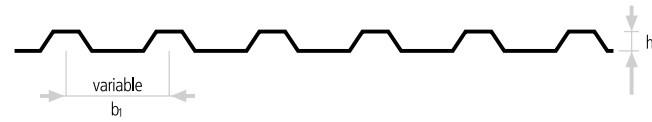

SW-H-R		3,000/5,500
--------	--	-------------

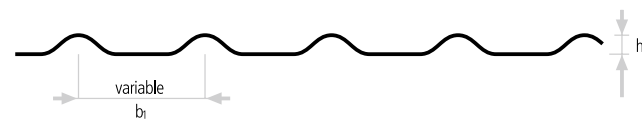

SZ-H-R		3,000/5,500
--------	--	-------------

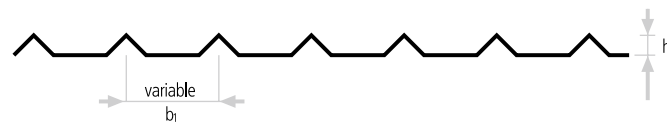

SZ-A-R		3,000
--------	--	-------

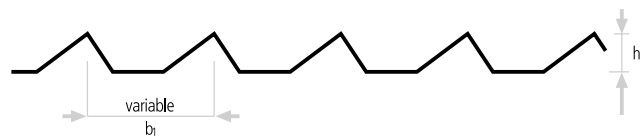

SQ-5/5-R		3,000
----------	--	-------

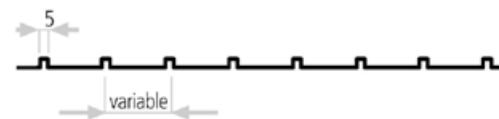
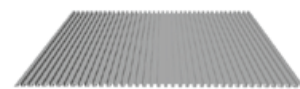

SQ-12/12-R		5,500
------------	--	-------

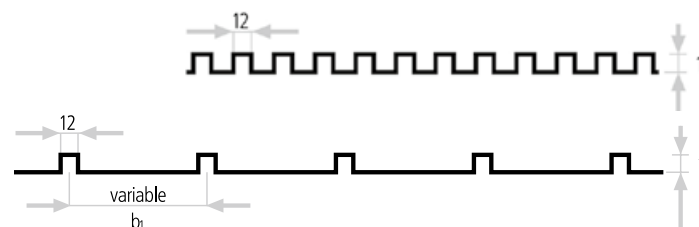

ARTICLE NUMBER	DRAWING	MAX. LENGTH IN MM
SQ-20/20-R		5,500

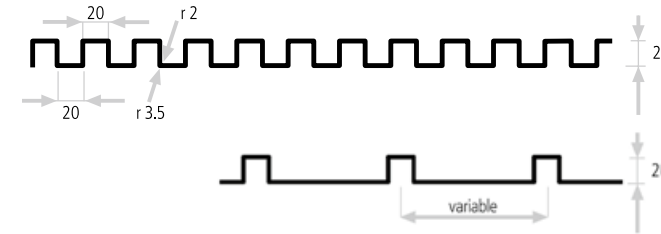

SQ-23/23		5,500
----------	--	-------

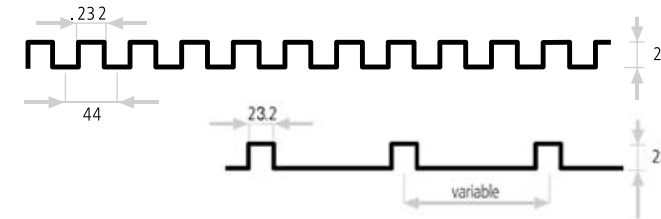

SQ-30/30		5,500
----------	--	-------

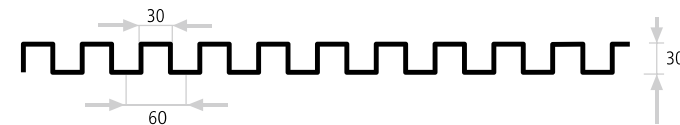

SZ-13/33		2,500
----------	--	-------

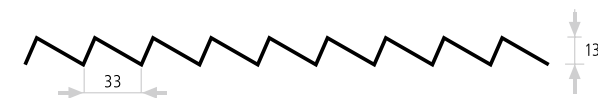

SZ-25/50-R		5,500
------------	--	-------



SZ-25/50-R	Reflective	5,500
------------	------------	-------



SZ-35/35-R	b_1 min. 68.50 mm	5,500
------------	---------------------	-------

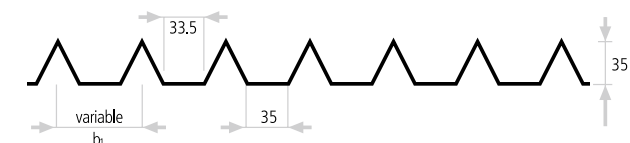

Registered design, number from the German Patent and Trade Mark Office (DPMA): 202 02 872.0

ARTICLE NUMBER DRAWING MAX. LENGTH IN MM

SZ-30/60-R 5,500

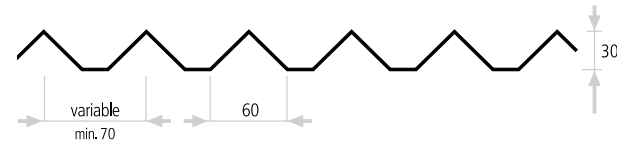

SZ-39/60-R b_1 min. 70 mm 5,500

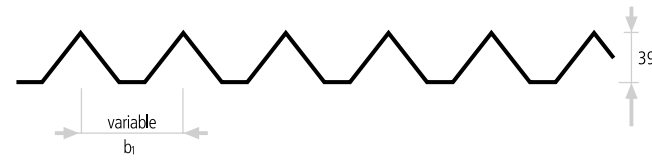

SW-25/113 3,000

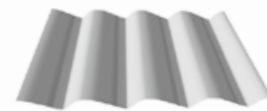

SR-15/22-R 3,000



SR-15/40-R 5,500

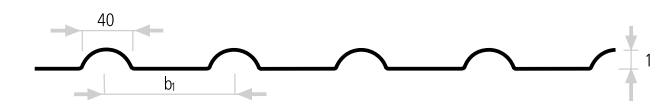

ZW-1.5/4 3,000

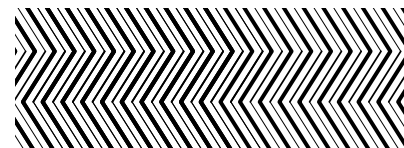
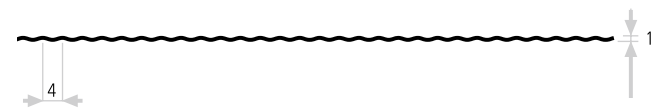

WW-1.5/5 3,000

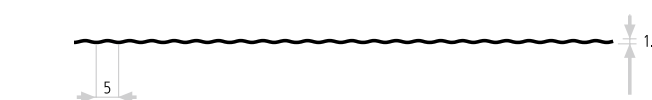

Scalloped and zigzag flashing for all profiles. The dimensions given for profile height and width are approximate only.

ARTICLE NUMBER DRAWING MAX. LENGTH IN MM

SP1-40/50-R b_1 min. 100 mm 4,000

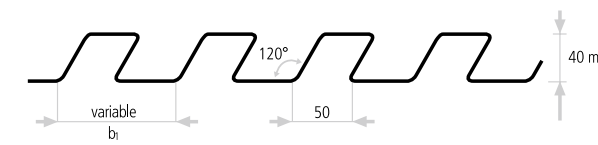

SP1G-40/50-R b_1 min. 100 mm 4,000

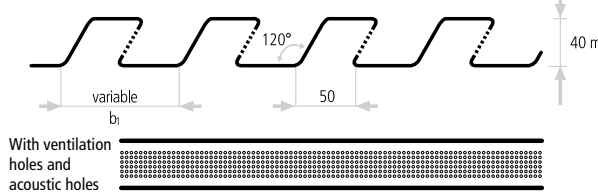

SP2-40/50-R b_1 min. 75 mm 5,500

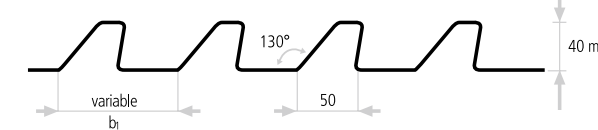

SP2G-40/50-R b_1 min. 75 mm 5,500

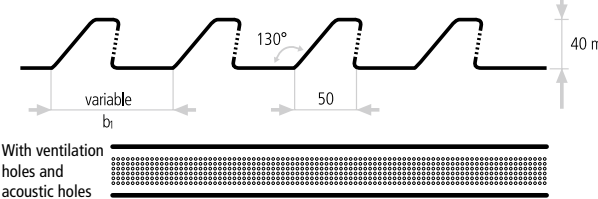

SP3-50/60-R b_1 min. 100 mm 3,000

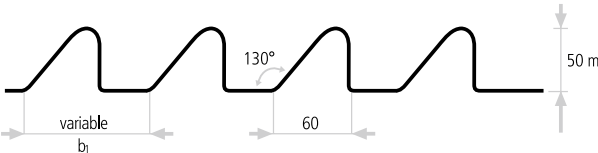

SP3G-50/60-R b_1 min. 100 mm 3,000

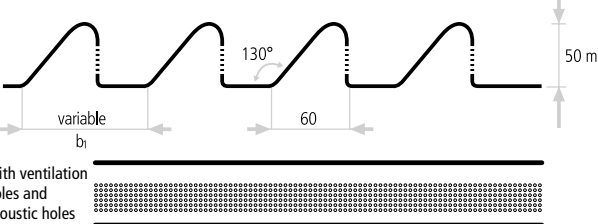

SPW-35/80-R b_1 min. 100 mm 3,000

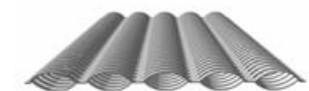
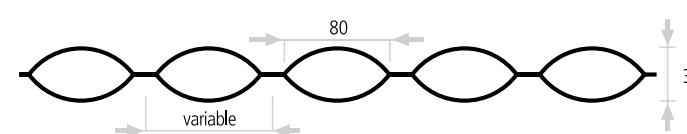

All of our welltec® products are also available in perforated versions with single-hole patterns, complete perforation, etc.

Extrusion enables the production of profiles with very complex shapes. MN processes a wide range of metals into extruded panels for use in the construction or automotive industries. Through powder coating, the profiles are also available in customised colours in accordance with the RAL and NCS charts.

ARTICLE NUMBER DRAWING

W-6/15 Standard profile

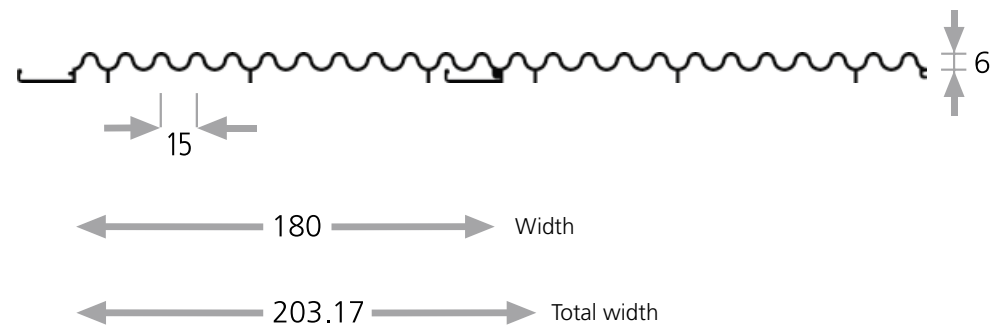

W-6/15 Lower flashing



is inserted into profile W-6/15

Giga® cassettes by MN Metall are variable modular systems. The cassettes are available in lengths of up to 3,000 mm. The profile forms shown in the product

list form the basic MN range and are also available as a perforated version. Please do not hesitate to contact us if you have any questions.

Highlight facades by combining Giga® profile shapes as you please.

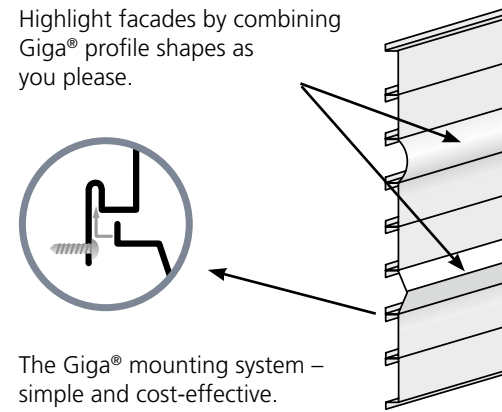

The Giga® mounting system – simple and cost-effective.

An alternating arrangement of convex and concave profiles also creates waves in new size dimensions.

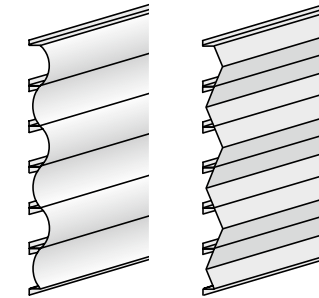

ARTICLE NUMBER

DRAWING

ARTICLE NUMBER

G-E 50/250

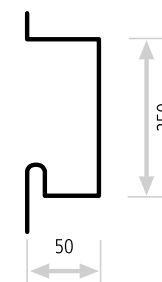

G-T 70/250

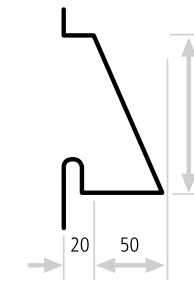

G-DA 70/250

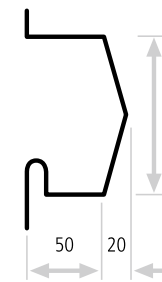

G-DI 50/250

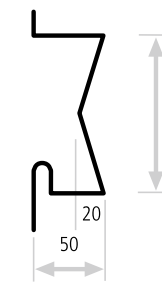

G-RA 70/250

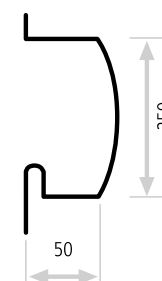

G-RI 70/250

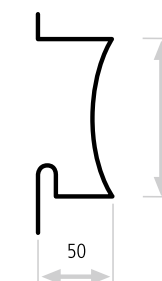



DESIGN MEETS FUNCTIONALITY

planTEC® DESIGN PROFILES FOR WALLS, CEILINGS AND FLOORS

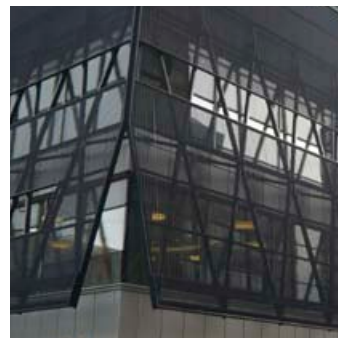

Hard Turm Park, Zurich

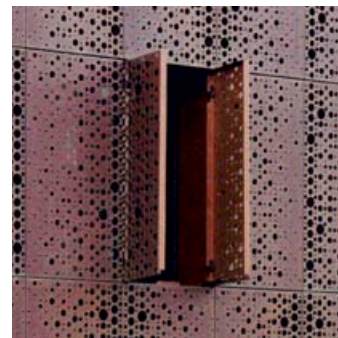

Hotel Prinz Albert, Luxembourg



Hotel Prinz Albert, Luxembourg

With their versatile patterns, planTEC® perforated and embossed sheets by MN offer an exhaustive range of cladding options for walls, ceilings and floors. With a regular structure, asymmetrical design or customised patterns, they not only serve as an optical eye-catcher, but also provide a high degree of functionality. For example, perforated sheets can be used for acoustic insulation and backlighting, whilst embossed sheets can be supplied with high load-bearing properties

and can be used, for example, for non-slip stair and floor coverings.

The product overview presents just a few examples of the planTEC® range. In addition to standard perforations, MN also produces custom-designed, variable patterns using all sheet types and surface coatings. Ask us for advice without any obligation – we look forward to discussing your requirements with you!

DIVERSE PERFORATIONS AND EMBOSSING

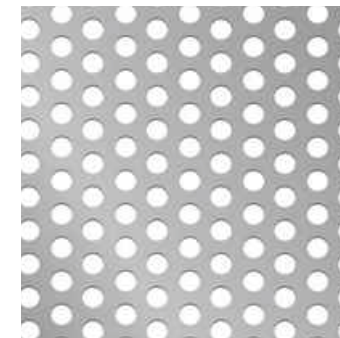

Perforations in offset rows

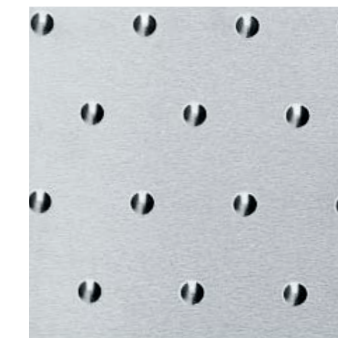

Round studs in offset rows



Round studs with various diameters and embossing depths

Thanks to our state-of-the-art production technology, we can create practically any perforated design. Whether round, square or long-hole perforations, clients have a variety of options concerning hole quantity and usable spaces. Ample scope for architecture and design is also provided by a wide selection of embossed patterns and combined

shapes, such as perforations with embossing. Using our basic elements, such as a square perforation measuring 10 × 10 mm or a round stud with a basic diameter of 12 mm, you can generally determine the patterns by yourself by specifying the grid or distribution of irregular patterns and the position of individual elements.

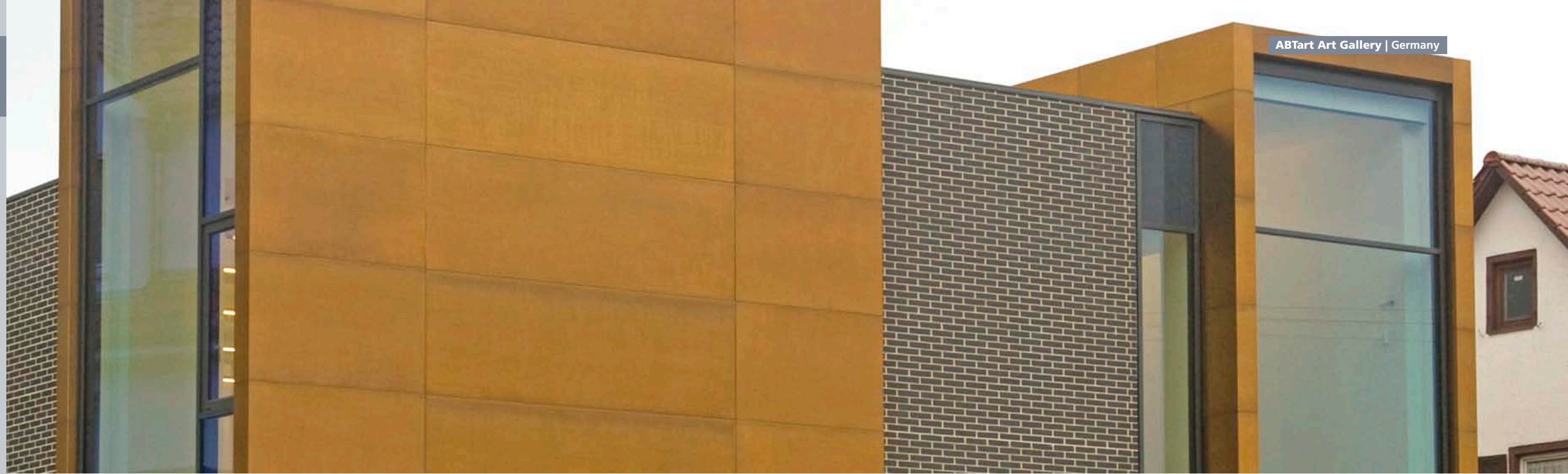

OTHER ADVANTAGES OF planTEC®



Window shutters/sun shade made of perforated sheet

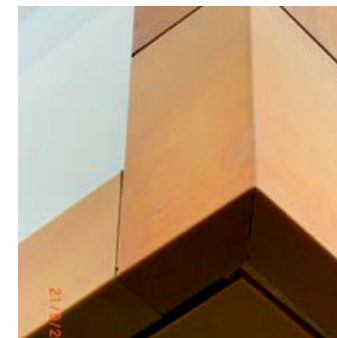

Cassettes



Shingles



Perforated/embossed composite panels

IMPRESSIVE DIMENSIONS AND FLEXIBILITY

planTEC® perforated and embossed sheets are available in special lengths of up to 7,000 mm and material thicknesses up to 20 mm. Customised productions with extremely tight manufacturing tolerances are also possible. The diverse range of materials and possible applications of planTEC®, in addition to the high dimensional accuracy in production, demand the highest precision and flexibility when it comes

to fixing. planTEC® perforated and embossed sheets can be fixed in a wide variety of ways in accordance with the specific construction conditions at hand. If desired, profiles can also be fitted with concealed fixings and can be produced to meet the specific conditions of the construction site in question or supplied as complete components.

MATERIAL RANGE

In interior design, style options are endless. This is why planTEC® perforated and embossed sheets can be produced using all metals. This includes aluminium, stainless steel, copper, steel, titanium zinc, brass and all other metals.

SURFACE RANGE

Your design ideas and functional requirements are important to us. As a result, planTEC® design sheets are available in all finishes, for instance stained, polished, sandblasted, textured, anodised or etched.

COLOUR RANGE

Stability and safety are paramount factors with planTEC® profiles by MN. High-quality paint in all RAL colours and shades guarantees a perfect appearance.



planTEC® system cassette, AlMg3, perforated
(Dimensions: 1,510 × 1,510 mm, thickness: 4 mm)

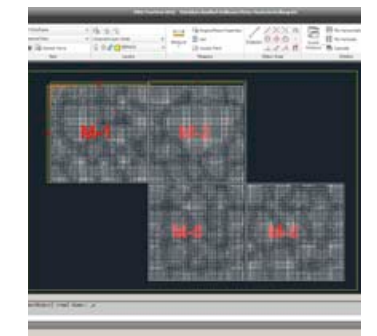
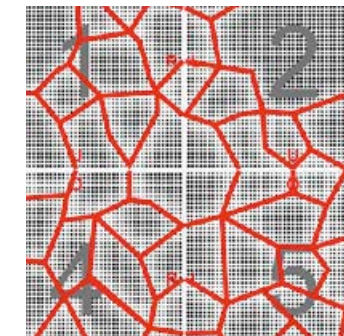
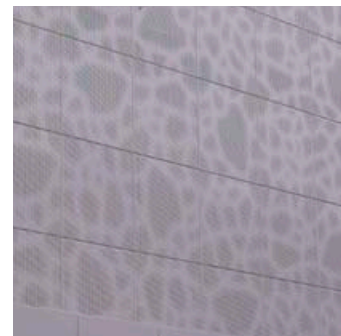

Photographic templates from the architect

Coordinate determination in CAD program

Division into parameters

DETAILED PRINT PERFORATION

The times when building cladding was based on rigid grids are undoubtedly over. Now, with the help of print perforation technology, a large array of photos or graphics can be used as templates for facade elements. Thanks to cutting-edge machine technology, MN Metall embosses, cuts and perforates all metals, can be used with diverse surfaces and creates highly detailed designs. This enables architects to think more creatively and plan more freely in the development of facade cladding concepts.

During print perforation, original architect's drawings are generated by a CAD program that records all shapes, perforations and embossing. The result is digitally projected onto the building surface to be covered in order to simulate the effect and enable any readjustments to be made.

Next, the electronic pattern and structural data is transmitted to computer-controlled machines, which in turn create a detailed reproduction of the profiles. After their completion, the panels are custom-mounted onto the building substructure.

Thanks to print perforation, architects can use countless motifs as a template for facade cladding. This results in extremely creative and intricate building surfaces.



Digital simulation



Computer-controlled, machine implementation

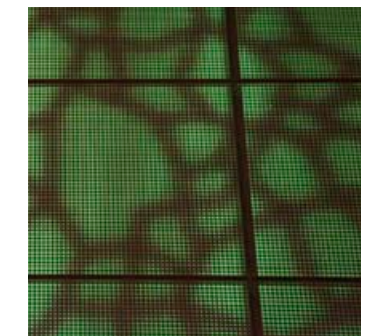

Custom-mounting of the panels

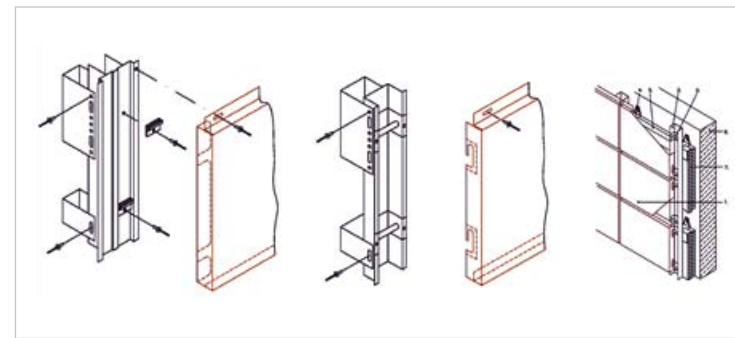

Waterfront Building,
Stockholm/Sweden



Waterfront Building,
Stockholm/Sweden



Waterfront Building,
Stockholm/Sweden

SYSTEM CASSETTES

MN system cassettes can be produced from 2,000 mm coil width to a length of up to 6,000 mm and a material thickness of up to 6 mm. Both shape and size can be selected as required by the client, and smooth, perforated or embossed surfaces are all possible.

wellTEC® and planTEC® products are generally compatible with all standard substructure systems from many well-known manufacturers. We offer special solution support during the development and production of customised substructures.



Metal facade with customised positive/negative embossing, creating diverse light reflections.



Diamond-shaped shingles system with special surface structure

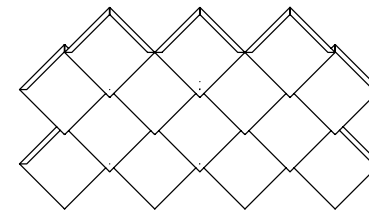

Checked shingle shape

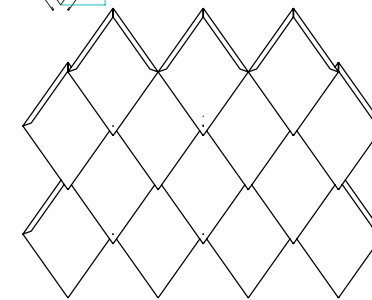

Diamond shingle shape

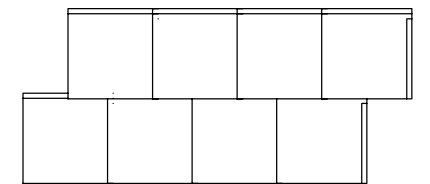

Square shingle shape

SHINGLES

Shingles by MN Metall offer a high degree of flexibility. They can be customised in terms of height and width and are available with all design surfaces. The shingles are manufactured using aluminium, stainless steel, zinc or copper, and are fixed with the standard

adhesion procedure. For metal shingles with circumferential seams, the roof or facade surfaces are given clearly organised linear or diagonal structures through a choice of grids.

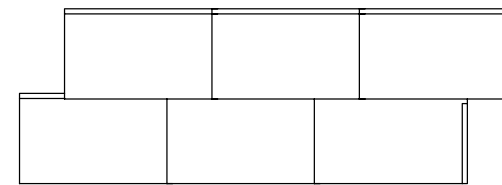
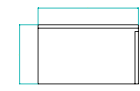

Rectangular shingle shape

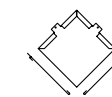

Direct mounting

ARTICLE NUMBER

DRAWING

EXAMPLES

RNg 7-t

Round stud, straight, (ball-shaped)

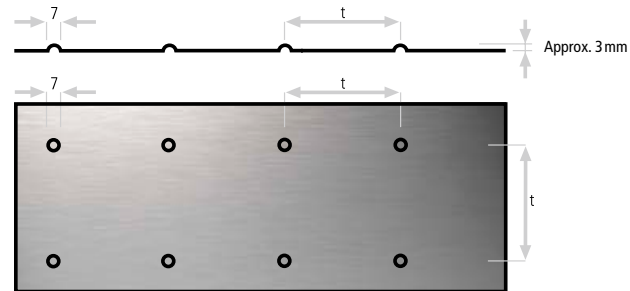

t min. 40 mm
c = 1.5 mm

Formats:
1,000 × 2,000 mm
1,250 × 2,500 mm
1,500 × 3,000 mm

RNV 7-t

Round stud, offset, (ball-shaped)

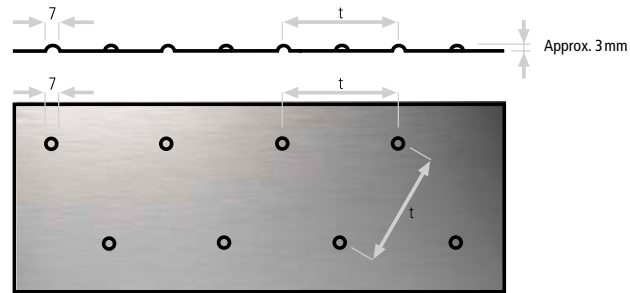

t min. 40 mm
c = 1.5 mm

Formats:
1,000 × 2,000 mm
1,250 × 2,500 mm
1,500 × 3,000 mm

RNg 10-t

Round stud, straight, (ball-shaped)

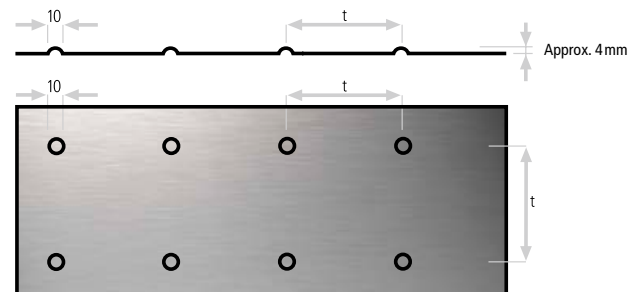

t min. 50 mm
c = 1–2 mm

Formats:
1,000 × 2,000 mm
1,250 × 2,500 mm
1,500 × 3,000 mm

RNV 10-t

Round stud, offset, (ball-shaped)

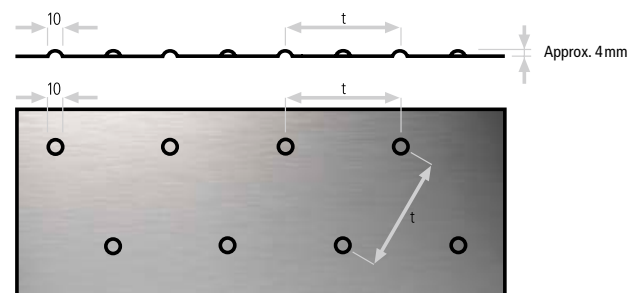

t min. 50 mm
c = 1–2 mm

Formats:
1,000 × 2,000 mm
1,250 × 2,500 mm
1,500 × 3,000 mm

ARTICLE NUMBER

DRAWING

EXAMPLES

RNg 12-t

Round stud, straight, (ball-shaped)

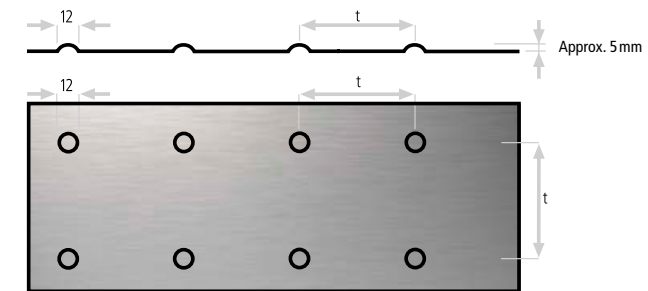

t min. 50 mm
c = 2–3 mm

Formats:
1,000 × 2,000 mm
1,250 × 2,500 mm
1,500 × 3,000 mm

RNV 12-t

Round stud, offset, (ball-shaped)

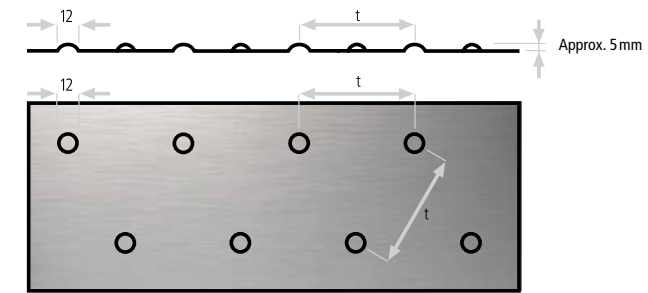

t min. 50 mm
c = 2–3 mm

Formats:
1,000 × 2,000 mm
1,250 × 2,500 mm
1,500 × 3,000 mm

RNg 15-t

Round stud, straight, (with plateau)

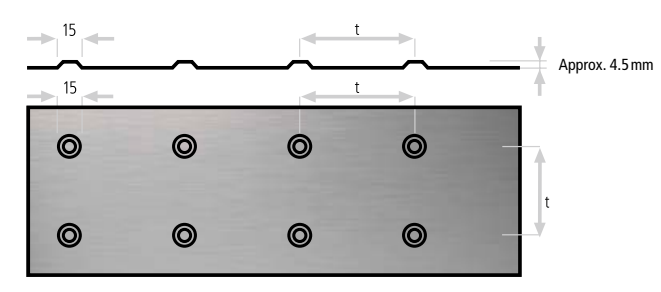

t min. 50 mm
c = 2 mm

Formats:
1,000 × 2,000 mm
1,250 × 2,500 mm
1,500 × 3,000 mm

RNV 15-t

Round stud, offset, (with plateau)

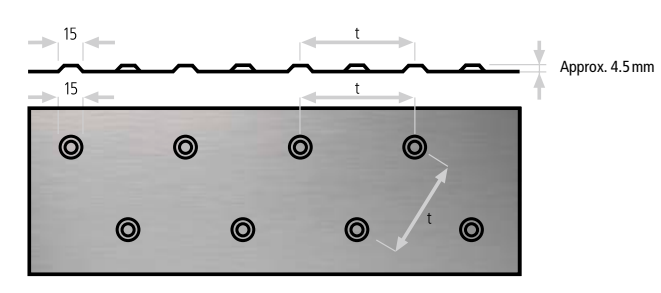

t min. 50 mm
c = 2 mm

Formats:
1,000 × 2,000 mm
1,250 × 2,500 mm
1,500 × 3,000 mm

ARTICLE NUMBER

DRAWING

EXAMPLES

RNg 25-t

Round stud, straight, (ball-shaped)

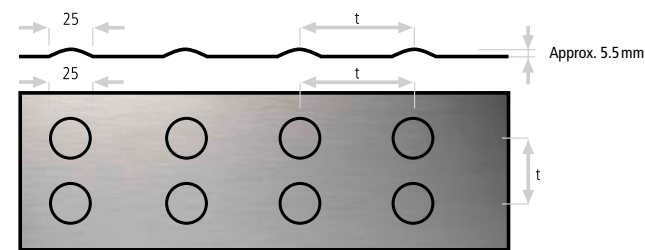

t min. 80 mm
c = 1.5 mm

Formats:
1,000 × 2,000 mm
1,250 × 2,500 mm
1,500 × 3,000 mm

RNv 25-t

Round stud, offset, (ball-shaped)

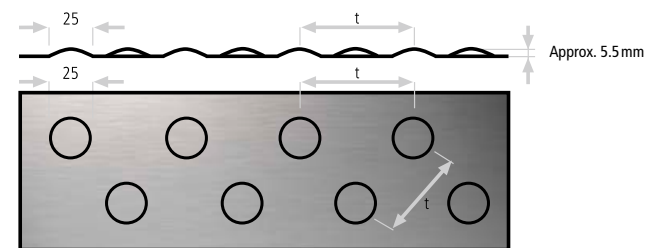

t min. 80 mm
c = 1.5 mm

Formats:
1,000 × 2,000 mm
1,250 × 2,500 mm
1,500 × 3,000 mm

RNg 15-36.38

Round stud, straight, (with plateau)

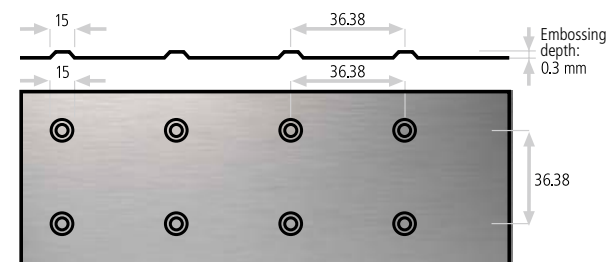

c = 2 mm (1.5)

Formats:
1,000 × 2,000 mm
1,250 × 2,500 mm
1,500 × 3,000 mm

ARTICLE NUMBER

DRAWING

EXAMPLES

PNg 8-t

Pyramide stud, straight

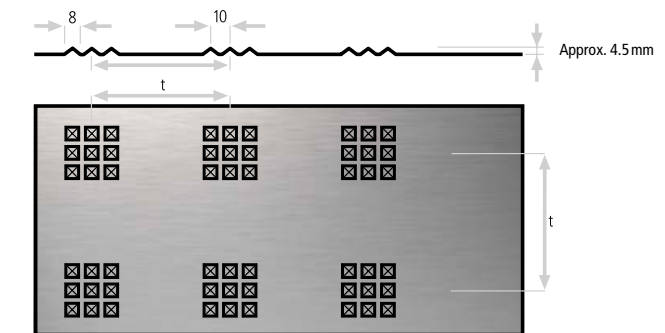

t min. 60 mm
c = 1.25 mm

Formats:
1,000 × 2,000 mm
1,250 × 2,500 mm
1,500 × 3,000 mm

PNv 8-t

Pyramide stud, offset

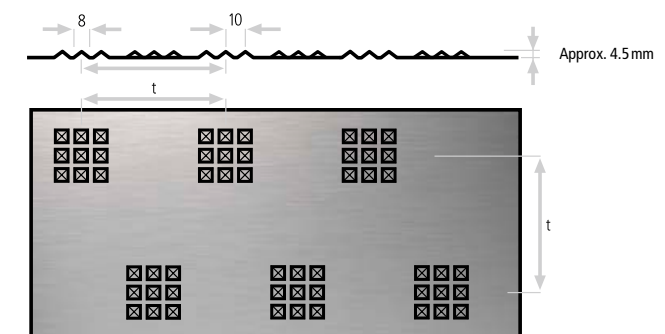

t min. 60 mm
c = 1.25 mm

Formats:
1,000 × 2,000 mm
1,250 × 2,500 mm
1,500 × 3,000 mm

PNg 6/6

Pyramide stud

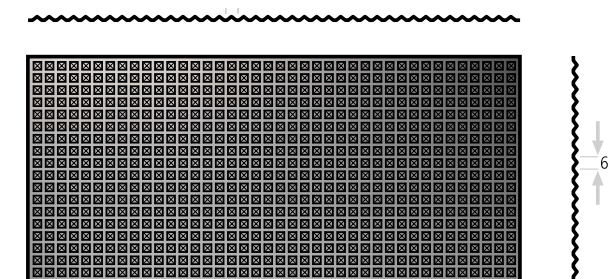

c = 1 mm

Length:
6,000 mm

ARTICLE NUMBER

DRAWING

EXAMPLES

QNg 25-t

Square stud, straight

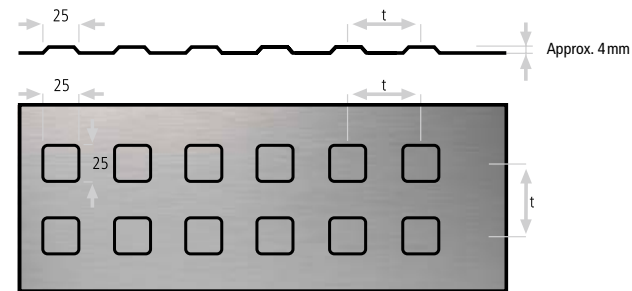

t min. 50 mm
c = 2 mm

Formats:
1,000 × 2,000 mm
1,250 × 2,500 mm
1,500 × 3,000 mm

QNv 25-t

Square stud, offset

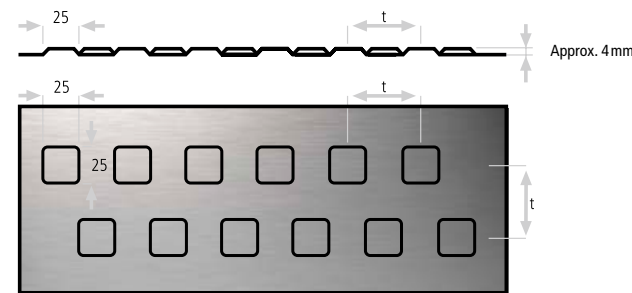

t min. 50 mm
c = 2 mm

Formats:
1,000 × 2,000 mm
1,250 × 2,500 mm
1,500 × 3,000 mm

KS-2.5/82

Cross bead

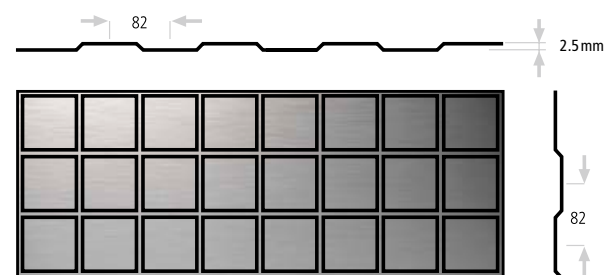

Cross-shaped
Profiled in
82-mm grid

Sheet format:
1,250 × 2,500 mm

ARTICLE NUMBER

DRAWING

EXAMPLES

TS-20/80

Trapezoidal bead

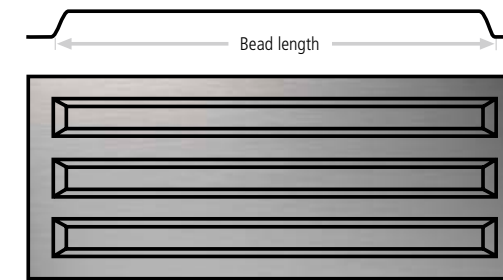

Bead lengths

444 mm
974 mm
2,174 mm

RS-15/40

Round bead

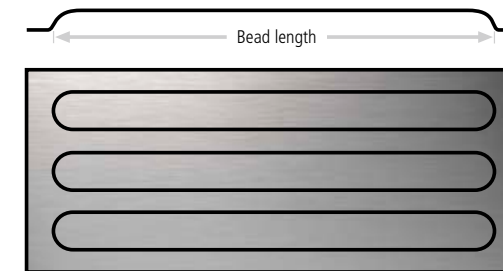

Bead lengths

1,000 mm to
5,000 mm

Round stud, irregular

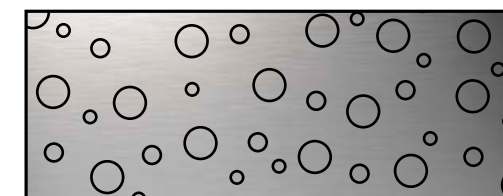

c = 1–2 mm

Formats:
1,000 × 2,000 mm
1,250 × 2,500 mm
1,500 × 3,000 mm



INFINITE APPLICATIONS, THE SAME HIGH QUALITY

colTEC® COLUMN CLADDING

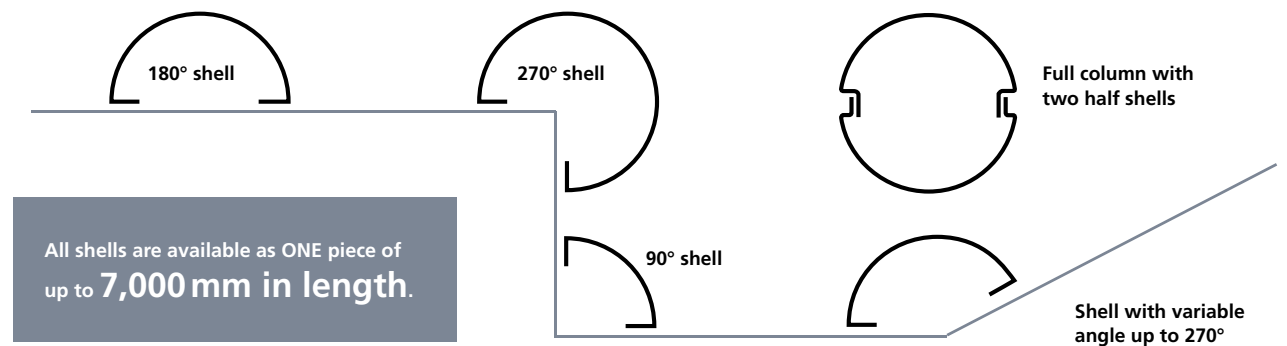

colTEC® column cladding by MN can be used in a variety of different architectural settings. In public buildings, hotel foyers, hospitals and trade fairs, they serve to enhance the appearance of columns often used as static elements. The high-quality and modern design sheets can be made using all types of sheet metal with any surface coating. A variety of perforation

designs away from the norm is also possible. If necessary, functional elements such as switches or sockets can be integrated or special effects created through backlighting. Discover the infinite range of design and usage options presented by colTEC® design sheets and prepare to be impressed by high-quality and modern column cladding.

DIVERSE DESIGNS

colTEC® profiles can be produced up to a length of 7,000 mm and a thickness of 20 mm in one sheet. They offer an extremely flexible column cladding option, since alongside their classic use as full columns, they can also be employed

as half or quarter shells to adorn walls or corners. With the help of precise laser cuts, it is possible to smoothly integrate functional elements or achieve special effects through backlighting.

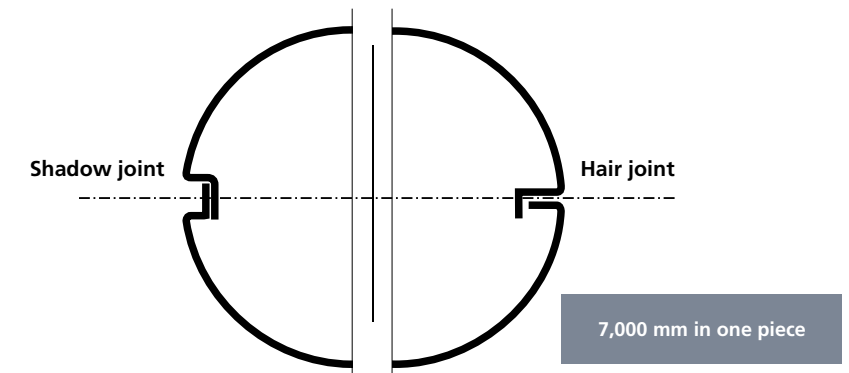

MATERIALS, SURFACES, COLOURS

colTEC® profiles create stunning effects in a large variety of models and materials. They can be produced using all metals, such as stainless steel, brass, steel, titanium zinc, aluminium and copper. The design sheets are also offered in all finishes imaginable, from

stained, polished or sandblasted to textured, anodised or etched. In order to create harmony between the column and other architectural elements, colTEC® column cladding by MN Metall can also be painted in all RAL colours and shades.

FLEXIBLE JOINT DESIGNS

In the area of joint design, colTEC® column cladding can also be adapted to the specific requirements at hand. Joints can either be deliberately emphasised through shadow

joints or subtly camouflaged by means of hair joints with concealed fixings. Pieces are produced without horizontal joints or spot welds on seams.

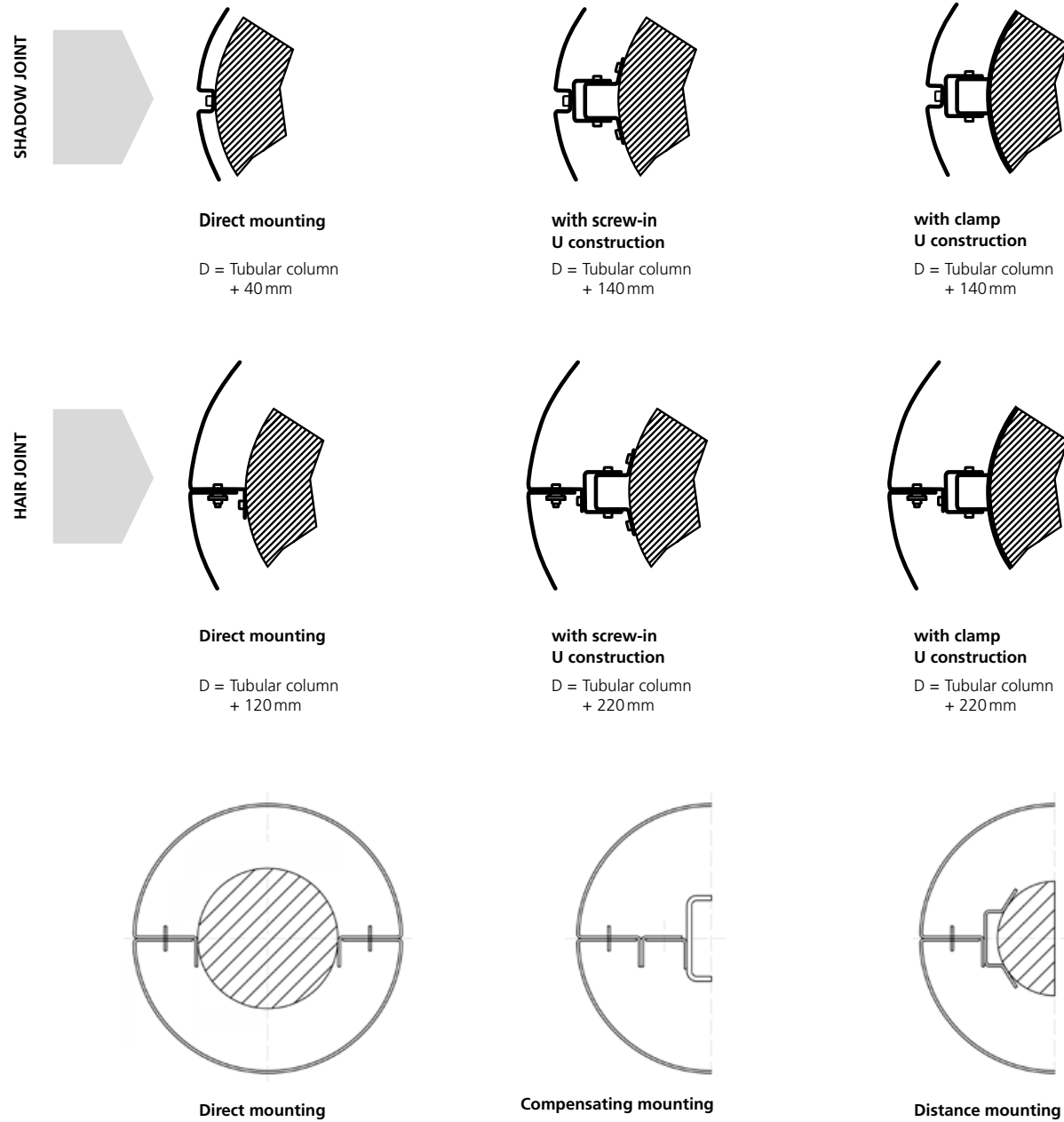

DIVERSE FIXING TYPES

colTEC® column cladding can be fixed in a wide variety of ways in accordance with the specific structural conditions. With direct mounting on the column substructure, it is possible to adjust various column shapes and dimensions to the column substructure using special top-hat and C profiles as spacers. If direct mounting on the

column substructure is not possible, clamping devices represent the best fixing method. The illustrated options are only a few examples of the large selection of possible fixings based on your needs and requirements. All versions can be supplied with both shadow and hair joints.

The column cladding included in our product list only represents our basic range. Please do not hesitate to contact us if you have specific requests. We look forward to your enquiry.

ARTICLE NUMBER	DRAWING	DRAWING	EXAMPLES
RK-S round	Joint design: shadow joint	Joint design: hair joint	RK-H round

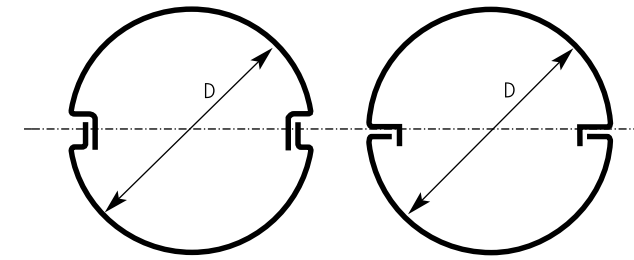

RE-S oval	Joint design: shadow joint	Joint design: hair joint	RE-H oval
------------------	----------------------------	--------------------------	------------------

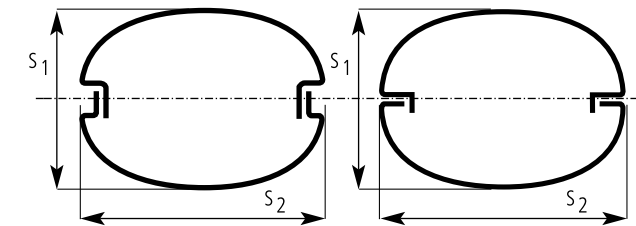

ED-D triangle	Joint design: shadow joint	Joint design: hair joint	ED-H triangle
----------------------	----------------------------	--------------------------	----------------------

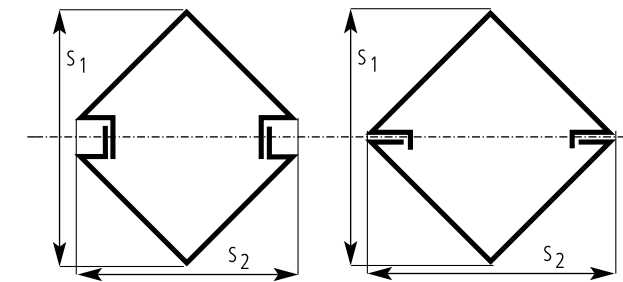

ER-S rectangle	Joint design: shadow joint	Joint design: hair joint	ER-H rectangle
-----------------------	----------------------------	--------------------------	-----------------------

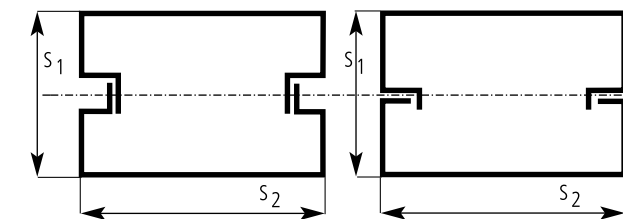

EP-S polygon	Joint design: shadow joint	Joint design: hair joint	EP-H polygon
---------------------	----------------------------	--------------------------	---------------------

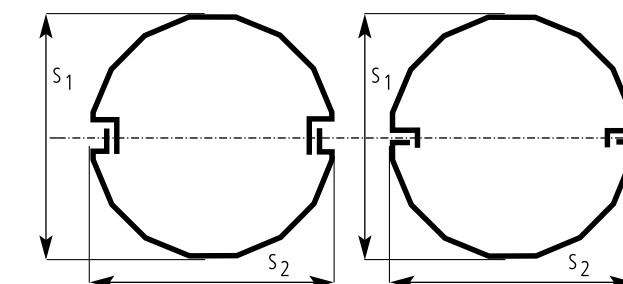



Profile SZ-30/60 R75, (thickness: 1.5 mm), Aluminium, perforated, RV3-4 and unperforated
The so-called *Röckli* (skirting) also serves as a sun shade

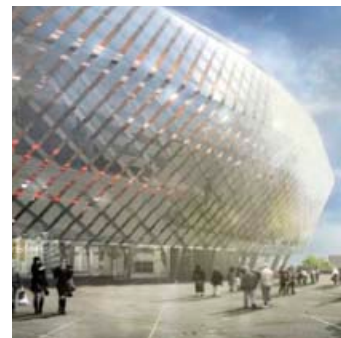

IMPRESSIVELY UNIQUE: MN SPECIAL SOLUTIONS

Alongside bringing its own products and advantages to the fore, an inherent part of the MN corporate philosophy is to look for customised, dimensionally precise and cost-saving solutions and suitable designs for its clients. Our high level of customer satisfaction is proven by countless long-term business relations and different quality certificates.

Nowadays, striking aluminium profiles supplied by MN Metall can be seen on a number of iconic buildings designed by renowned architects, who consciously opt for these products based on their convincing properties. Such buildings include the Stockholm Arena in Sweden and the sculptural Festival House in Blackpool, which is surrounded by a diamond-shaped metal facade supplied by MN Metall. Thanks to a special

surface structure with multi-spectral colours, this cladding achieves a truly unique aesthetic effect. The same goes for the cassette facade of the Landeskirchliches Archiv in Nuremberg, the matt shimmering copper exterior of which develops a silky brown surface as it passes through the various stages of oxidation.

Another excellent reference is the NYA Nordiska industrial complex with its red anodised aluminium facade elements supplied by MN Metall. This construction project was selected by an expert jury to receive the Lower Saxony state architecture prize.

If you, too, are interested in high-quality and exclusive special solutions in the area of building cladding, please do not hesitate to contact us!

Landeskirchliches Archiv, Nuremberg
Exterior walls made of matt shimmering copper with a fine, vertical structure

Cassette fixing,
Landeskirchliches Archiv

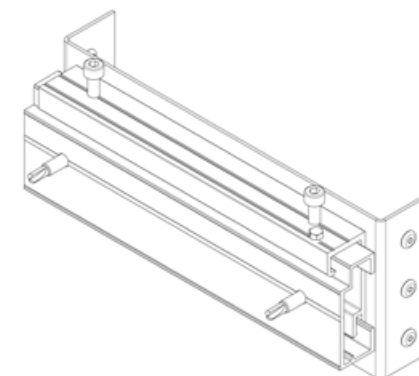

Agrafe for 190 mm-wide cassette



Kulneva, Moscow
The 2,000 mm-wide basic material was dyed half in champagne, half in black using a multi-spectral process. It was then edged and relief-milled in one piece in order to obtain as low an edge radius as possible.

Flashings by MN Metall can be manufactured using all metals with any desired finish. They are available in thicknesses from 0.75 mm to 4 mm and lengths of up to 5,000 mm. Special lengths up to 7,000 mm are also

possible upon request. Profiles are cut to any desired length and can be prepared with specific perforations or shapes as required.

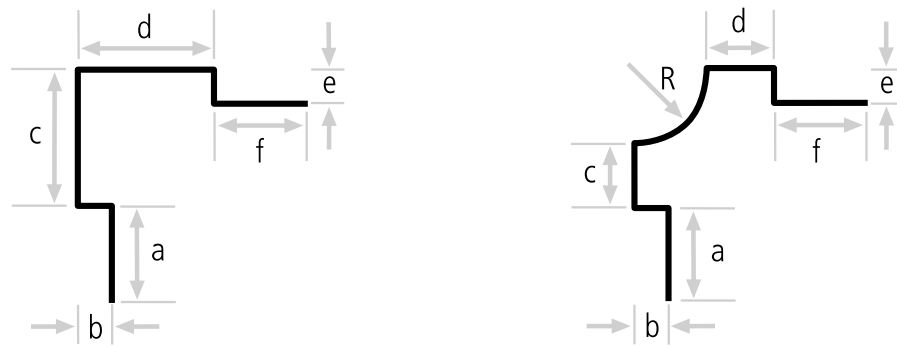

ARTICLE NUMBER DRAWING DRAWING ARTICLE NUMBER

E 01 Outside corner E 02 Inside corner



E 03 Pilaster E 04 Soffit



E 05 Lintel E 06 Windowsill



ARTICLE NUMBER DRAWING DRAWING ARTICLE NUMBER

R 01 Outside corner R 02 Inside corner



R 03 Pilaster R 04 Soffit

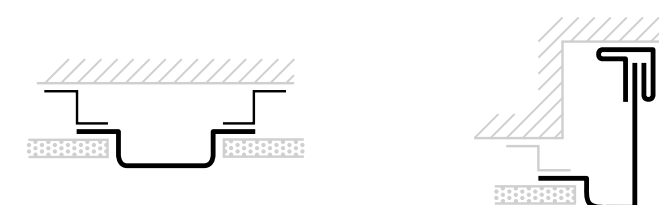

R 05 Lintel R 06 Windowsill

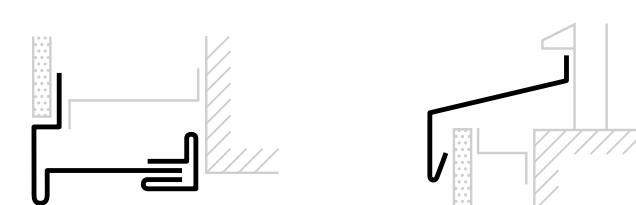

B 01 Outside corner B 02 Inside corner Series B



B 03 Pilaster B 04 Soffit

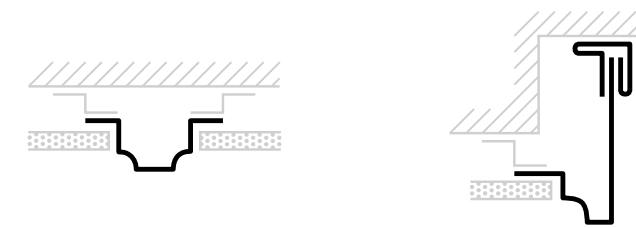

B 05 Lintel B 06 Windowsill



ARTICLE NUMBER DRAWING DRAWING ARTICLE NUMBER

K 01 Outside corner Outside corner **K 011**



K 02 Inside corner Inside corner **K 021**



K 03 Pilaster Pilaster **K 031**



K 04 Soffit Soffit **K 041**

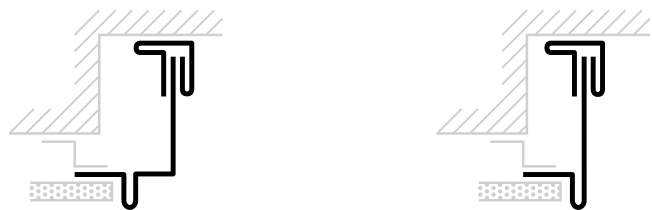

K 05 Lintel Lintel **K 06**



ARTICLE NUMBER DRAWING DRAWING ARTICLE NUMBER

S 01 Outside corner Inside corner **S 02**

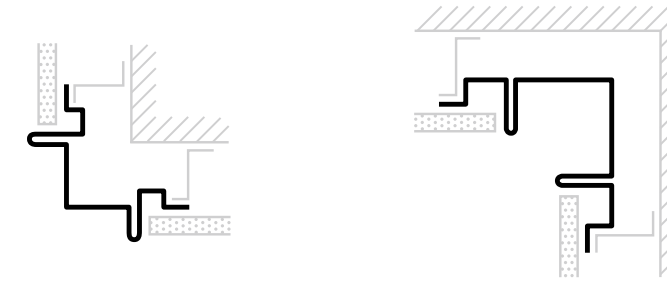

S 03 Pilaster Pilaster **S 31**



S 04 Soffit Lintel **S 05**

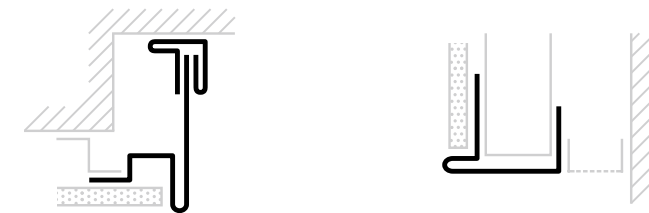

S 06 Windowsill

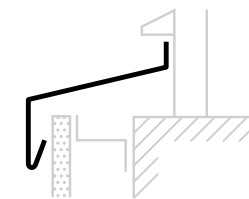

EXAMPLES OF USE

Outside corner

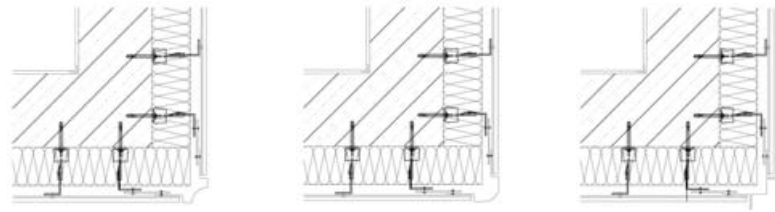

Windowsill

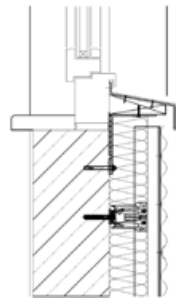

Window lintel



Inside corner

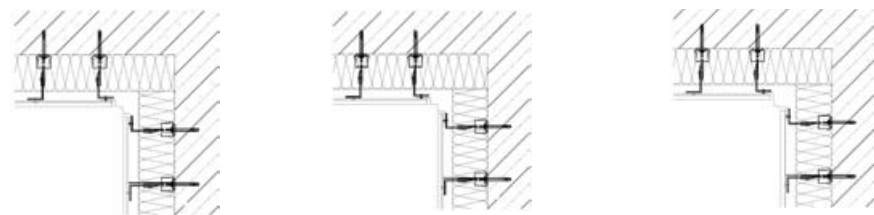

Soffit

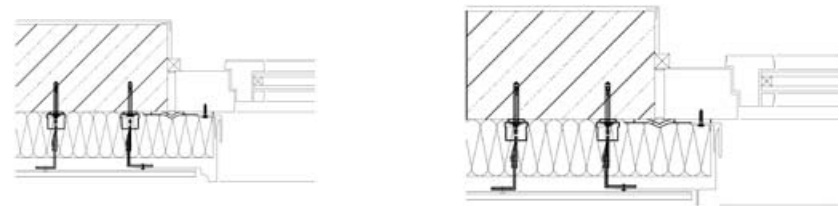

wellTEC[®] profile sheet system representation

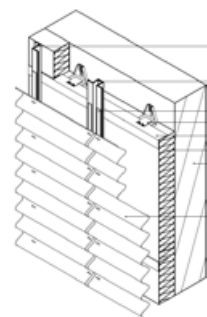

EXAMPLES OF USE

Socket connection

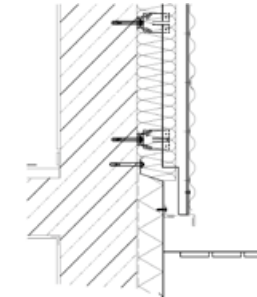

Parapet

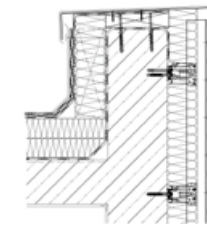

Joint, horizontal

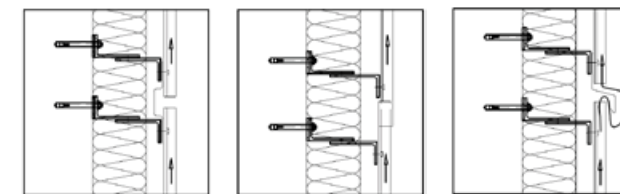

Facade section

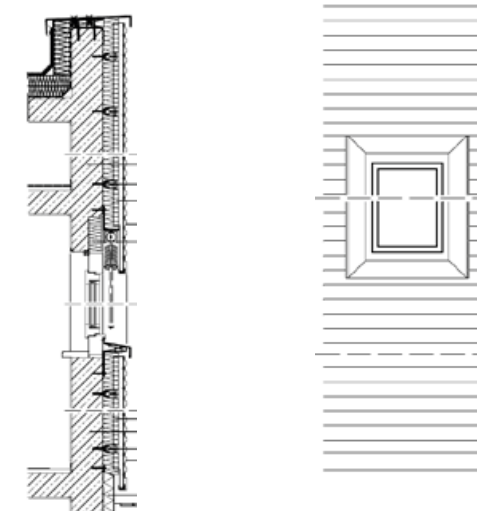

CONSULTING, PROJECT DESIGN, PRODUCTION

MN METALL OFFERS MORE THAN HIGH-QUALITY BUILDING CLADDING



In the area of commercial construction, MN Metall is one of the most reliable and modern manufacturers of building cladding. But far from resting on its laurels, MN Metall complements its building component production with a full-service programme that begins with consulting and planning and stretches all the way through to logistics management after pro-

duction. Our qualified employees are equipped with the necessary engineering expertise to grasp the complexity of a construction project and offer focused support and innovative solutions. Discover our wide-ranging service portfolio for yourself – from customised and series production all the way to international projects.



YOUR PROJECT DESERVES OUR FULL ATTENTION

Your construction project is important to us. For this reason, we dedicate our time and complete attention to your needs. Even during the developmental phase, our engineers and customer advisers can support architects and engineering firms by assuming tasks such as static calculations or planning. This enables the exploitation of important synergies at an early stage

of project conception, which could lead to increased construction quality and reduced costs later. Once the design of cladding elements has been completed, MN Metall collaborates with structural and facade engineers if the production of assembly and fixing profiles is required or logistic and assembly processes need to be optimised.

OTHER SERVICES BY MN METALL



TECHNOLOGY

High dimensional accuracy and minimum manufacturing tolerances can only be achieved with powerful processing machines. MN Metall has state-of-the-art system technology that is continuously adapted to meet the latest requirements. During the planning phase, we use 3D CAD models that enable engineers to present the visions of the architect in the actual space and under real conditions. This means that a range of factors can be tested, including building stability, the effects of wind or gravity and the load transfer between elements. This leads to a reduction in work defects, construction delays and not least, additional costs.



ENVIRONMENTAL MANAGEMENT

Environmentally friendly conduct should also – or perhaps particularly – be a focus of companies in the manufacturing industry. At MN Metall, the environment and sustainability play a pivotal role. This starts with minimising our use of natural resources (especially through recycling) and the reduction of pollution in production processes. Supplied materials have to meet high ecological standards in terms of their raw materials, production and processing. In addition to this, the high quality and durability of MN products makes a lasting contribution to the conservation of raw materials.



COIL SERVICECENTRE

In order to process metal, raw material is required. This is normally only available in standard trade sizes, which leads to a high level of wastage when it comes to processing special sizes. Thanks to the most modern coil servicecentre in Europe, MN can de-coil the basic material itself. Here, large aluminium or stainless coils with widths from 500 mm to 2,000 mm, thicknesses of up to 5 mm and weights of up to 25 t can be cut into individual sheets ranging from 150 mm to 8,000 mm in length and 100 mm to 2,000 mm in width. Based entirely on client requirements and with a minimum tolerance of just one thousandth of a millimetre on a length of 8,000 mm, blank and contour cuts are carried out and also meet the surface and edging needs of the automotive industry.

As an MN client, you benefit from stable cost structures, customised production options, an efficient value chain and a stunning, high-quality facade.



2D/3D lasers



Folding



Bending



Cutting



Welding

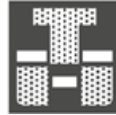

Punching



Coiling



Profiling



Plasma
cutting



Management system certified in
accordance with DIN EN ISO 9001